

See discussions, stats, and author profiles for this publication at: <https://www.researchgate.net/publication/306914478>

EFFECTS OF W/P RATIO AND LIMESTONE FILLER ON PERMEABILITY OF CEMENT PASTES

Conference Paper · August 2016

DOI: 10.13140/RG.2.2.14118.93766

CITATIONS

0

READS

67

5 authors, including:



Quoc Tri Phung

Belgian Nuclear Research Centre

28 PUBLICATIONS 76 CITATIONS

SEE PROFILE



Norbert Maes

Belgian Nuclear Research Centre

117 PUBLICATIONS 698 CITATIONS

SEE PROFILE



Diederik Jacques

Belgian Nuclear Research Centre

212 PUBLICATIONS 2,046 CITATIONS

SEE PROFILE



Guang Ye

Delft University of Technology

237 PUBLICATIONS 1,980 CITATIONS

SEE PROFILE

Some of the authors of this publication are also working on these related projects:



HPx: a flexible tool for coupled reactive transport for variably-saturated multi-dimensional flow & transport problems in porous media [View project](#)

Proceedings of the International RILEM Conference
Materials, Systems and Structures in Civil Engineering 2016
Segment on

Concrete with Supplementary Cementitious Materials

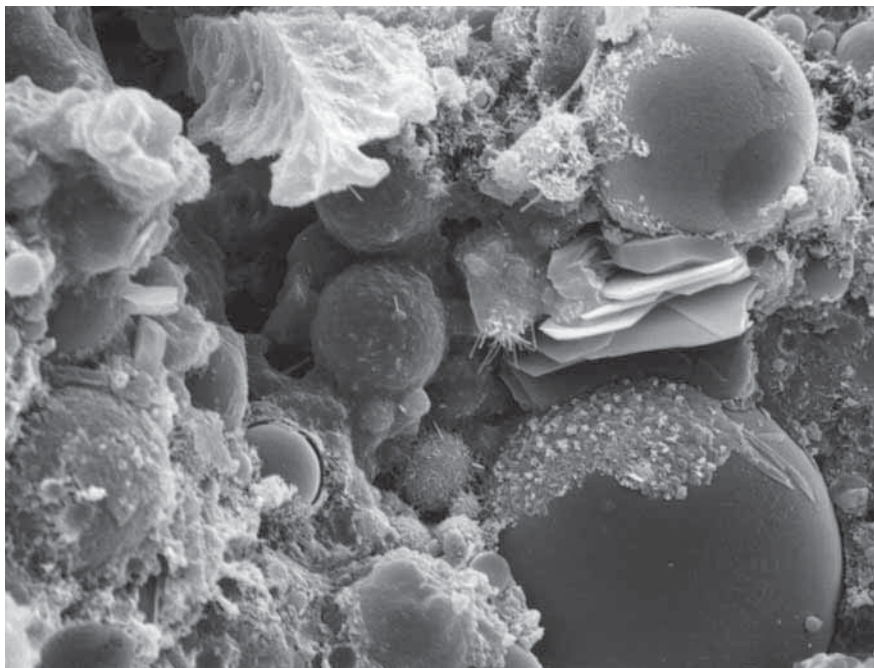

Edited by
Ole M. Jensen, Konstantin Kovler and Nele De Belie

**Proceedings
PRO 113**



EFFECTS OF W/P RATIO AND LIMESTONE FILLER ON PERMEABILITY OF CEMENT PASTES

Quoc Tri Phung⁽¹⁾, Norbert Maes⁽¹⁾, Diederik Jacques⁽¹⁾, Geert De Schutter⁽²⁾, Guang Ye⁽³⁾

(1) EHS Institute, Belgian Nuclear Research Centre (SCK•CEN), Belgium

(2) Magnel Laboratory for Concrete Research, Ghent University, Belgium

(3) Microlab, Delft University of Technology, The Netherlands

Abstract

Because of environmental and economic benefits, a fraction of cement is increasingly replaced by limestone fillers raising a question on to what extent limestone fillers affect the durability of cementitious materials. This work aims at understanding the effects of water/powder (w/p) ratio and limestone filler replacement on water permeability of cement pastes. A newly proposed technique using a controlled constant flow concept was applied to measure permeability of hardened cement paste samples following a factorial experimental design. It was observed that both limestone filler and w/p ratio significantly influence the water permeability. At a given w/p ratio, adding limestone filler made the microstructure coarser, especially for high w/p ratio. Nevertheless, if the comparison is based on a given water/cement (w/c) ratio instead of w/p ratio, the limestone filler replacement refined the microstructure in terms of capillary porosity and pore size distribution, resulting in permeability decreases of cement pastes. Furthermore, a modified Carmen-Kozeny relation was established which enables prediction of the permeability from capillary porosity and the critical pore diameter.

1. Introduction

Durability and performance of concrete are affected by a number of chemical degradation phenomena such as carbonation [1], calcium leaching [2], sulphate attack, chloride attack, and corrosion of the reinforcement bars [3]. Diffusivity and permeability of concrete determine how fast aggressive substances penetrate into concrete, thereby influencing almost all mentioned degradation mechanisms. Therefore, these are fundamental parameters for characterizing long-term performance of concrete rather than the standard compressive/tensile strengths.

There are many factors influencing the permeability of cement-based materials. Several factors are classified as extrinsic related to experimental conditions such as applied pressure,

size of sample [4] and confining pressure [5]. Variation of these factors can cause a change of several orders of magnitude in permeability. Beside extrinsic factors influencing the permeability include porosity, pore size distribution, tortuosity, specific surface and micro cracks. These parameters are basically controlled by the water to cement ratio, particle size distribution (cement + aggregate), age of sample and type of constituent materials. Concrete with larger pore size has higher permeability than concrete with smaller pore size despite the same total porosity. This effect is normally reflected through the critical pore size. It is obvious that pore connectivity is one of the most critical factors influencing the permeability. Pores which are blocked cannot transport any fluid. The type of constituent materials mainly affects permeability through hydration degree, especially at early ages. As shown in many studies [6-10], the permeability increases with increasing w/c ratio because of a higher porosity at higher w/c ratio. However, to the knowledge of the authors, no direct connection between water to cement ratio and permeability has been proposed. A direct relation between porosity and permeability has been introduced by some researchers [11-15]. Nevertheless, porosity alone should not be a unique factor influencing the permeability, i.e. samples with the same porosity may have different permeability. Few researchers have studied the effects of limestone filler replacement on permeability, but many questions still remain, though replacing part of cement by limestone fillers is getting more attention in recent years because of its environmental and economic benefits. Most studies [16-18] agree that there is no significant change in transport properties as long as limestone filler replacement is less than 10%. On the contrary, other studies [19, 20] found that oxygen permeability decreases with increasing limestone filler replacement. Some authors also state that concrete with limestone filler replacement increases the carbonation rate compared to concrete with the same water/powder (w/p) ratio [19, 21, 22].

In the present study, the newly developed method to measure permeability of saturated materials [23, 24] was applied to investigate the effects of limestone filler replacement and w/p ratio on permeability of cement pastes. The effects of microstructural properties on permeability were deeply studied. Furthermore, a modified Carmen-Kozeny relation was established which enables predicting the permeability from capillary porosity and the critical pore diameter.

2. Experiments

2.1 Materials

Experiments were performed on cement pastes made from cement, tap water and limestone filler. Type I ordinary Portland cement (CEM I 52.5 N) was used. The cement has quite high Blaine specific surface of 4350 cm²/g.

Limestone filler (Calcitec 2001S) used has a Blaine specific surface of 3500 cm²/g and a CaCO₃ content of 98.30%. Superplasticizer Glenium 27 was added to the mix with content of 0.5% with respect to mass of cement.

2.2. Factorial experimental program

In order to investigate the effects of w/p ratio and the cement replacement by limestone filler (ls/p) on water permeability, diffusion of dissolved gas, carbonation and Ca-leaching, a factorial experimental design (Table 1) has been proposed. In cement industry, Portland

limestone cements have been produced by inter-grinding clinker and limestone (and gypsum) in which different limestone/(limestone + clinker) ratios are initially chosen. Therefore, the “water/cementitious material” ratio for Portland limestone cement is actually the “water/powder” ratio. To keep consistence, w/p ratio and limestone filler replacement were chosen in this study instead of w/c ratio and limestone filler replacement. However, the dilution effect due to limestone filler addition can be easily investigated by converting w/p ratio to w/c ratio.

Table 1: Detail of factorial experiment design: LS = limestone filler; SP = superplasticizer

Run order	Cement kg	LS kg	Powder kg	Water kg	w/c -	w/p -	ls/p %	SP l	Sample
1	450	0	450	146	0.325	0.325	0	2.3	S1
2	360	90	450	191	0.531	0.425	20	1.8	S2
3	450	0	450	191	0.425	0.425	0	2.3	S3
4	405	45	450	169	0.417	0.375	10	2.0	S4
5	360	90	450	146	0.406	0.325	20	1.8	S5

2.3. Determination of water permeability using a controlled constant flow method

Cement paste was poured in a cylindrical PVC tube with inner diameter of 97.5 mm. The sample was cured in a sealed condition in a temperature controlled room ($22 \pm 2^\circ\text{C}$) for 27 days. The 28-day-cured cement paste was sawn into 25 mm thin slices embedded into the polycarbonate part of the permeability cells. The samples were afterwards saturated in lime water. The saturated samples were then connected to permeability setup (Fig. 1) to determine the saturated permeability using a controlled constant flow method as described in [24].

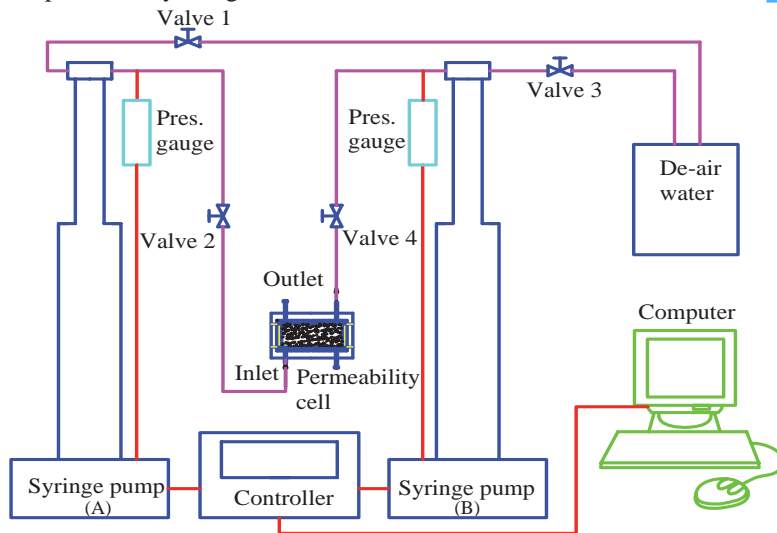

Fig. 1: Schematic test setup for permeability determination

3. Results and discussion

3.1. Factorial experimental results

The determined permeability coefficients of cement pastes with w/p ratios ranging from 0.325 to 0.425 and limestone filler replacement ranging from 0 to 20% (see Table 1 for the detail of mix design) are represented by cube and interpolated surface (using Akima's polynomial method [25]) plots in Fig. 2. It can be seen in the surface plot that, to improve the impermeability, one should choose a mix design with a low w/p ratio and low limestone filler replacement. In order to clearly visualize the effects of w/p ratio and limestone filler replacement on permeability, the main effects and interaction plots were built using statistical software Minitab [26]. The main effects plot (Fig. 3a) shows that the permeability strongly decreases with decreasing w/p ratio and limestone filler replacement. There does not seem to be a large difference in the magnitude of the effects of w/p ratio and limestone filler replacement as its quite similar slopes (referred to the changes of the response when factorial values vary from low to high levels). The regression equation (first-order) of logarithm of permeability coefficient is obtained as follows:

$$\log_{10}(k) = -17.65 + 12.47 \text{ ls/p} + 11.74 \text{ w/p} - 21.15 \text{ ls/p} \times \text{w/p} \quad (1)$$

where k is the permeability coefficient [m/s]; ls/p is the ratio of limestone filler over powder (cement + limestone filler); w/p is the ratio of water over powder. The correlation coefficient (r^2) is 0.9965 indicating that the predicted model fits the experimental data well.

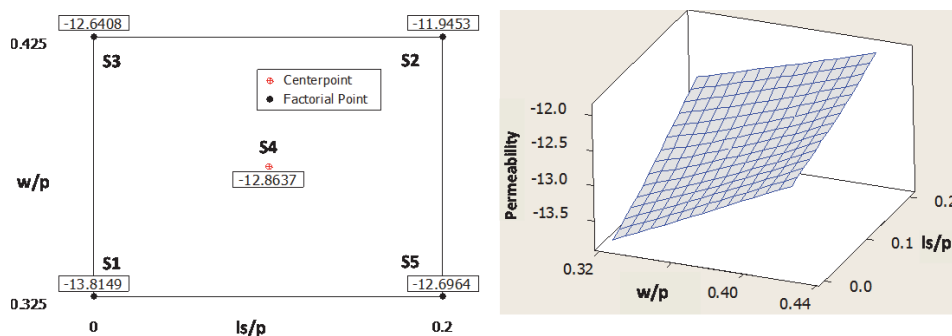

Fig. 2: Cube plot and interpolated surface plot of permeability (logarithmic transformation) vs. w/p ratio and limestone filler replacement (ls/p)

The interaction plot (Fig. 3a) enables us to visualize the interaction effect (i.e. the combined effects of factors on the dependent measure. When an interaction effect is present, the impact of one factor depends on the level of the other factor) of w/p ratio and limestone filler replacement on the permeability. As the connected lines of factor levels are not parallel to each other, there might be interaction. However, the interaction is not significant because the extent of departure is small. The interaction is getting stronger with the increase of w/p ratio and limestone filler replacement.

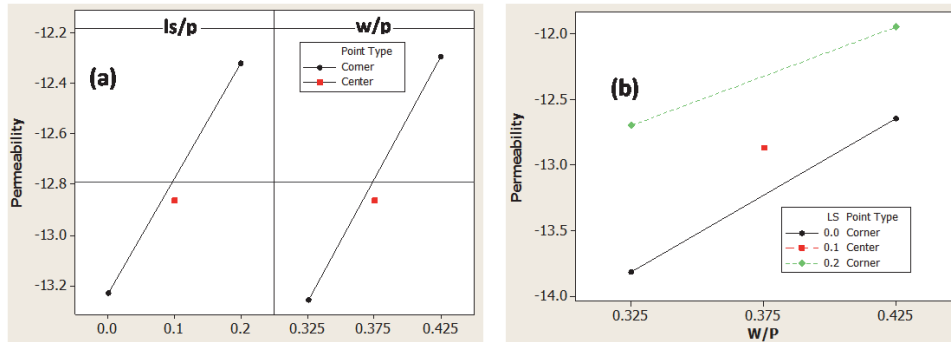

Fig. 3: Main effects plot (a) and interaction plot (b) for permeability (logarithmic transformation)

3.2. Pore structure and its effect on water permeability

The porosity and pore size distribution are shown in Fig. 4. At a given w/p ratio, adding limestone filler made the microstructure coarser, especially for high w/p ratio (i.e. sample S2 vs. sample S3). However, at a given w/c ratio, the limestone filler refined the microstructure of the cement pastes. As evidenced in Table 2, sample S3 had higher porosity and bigger average pore diameter compared to sample S4 (10% limestone filler replacement) despite its quite similar w/c ratio (0.425 and 0.416). In most cases, the samples with larger porosity and coarser pore size distribution resulted in higher water permeability. However, sample S5 did not follow the general trend as it showed higher water permeability despite smaller porosity and finer pore size distribution compared to sample S4 (see Fig. 4). This phenomenon might be a consequence of different air void content or macro pores in two samples. Unfortunately MIP experiment does not generally enable to detect air voids because air voids are only intruded after threshold pressure is reached, and thus counted for smaller pores. Furthermore, big pores may be intruded by mercury before increasing pressure, and are thereby not counted in total porosity.

Table 2: Summary of MIP results of reference samples

Parameters	S1	S2	S3	S4	S5
w/p	0.325	0.425	0.425	0.375	0.325
ls/p	0	0.2	0	0.1	0.2
Permeability coefficient, m/s:	$10^{-13.8}$	$10^{-11.9}$	$10^{-12.6}$	$10^{-12.9}$	$10^{-12.7}$
Accessible porosity, %:	10.40	23.65	16.48	13.73	12.92
Average pore diameter (4V/A), nm:	22.67	29.87	26.09	24.24	25.40
Critical pore diameter, nm:	25.74	49.87	32.00	36.41	29.03
Specific surface, m ² /g:	7.77	14.90	10.58	9.44	7.56

Fig. 5 compares the measured permeability with literature values. Note that only results of the mixtures without limestone filler (S1 and S3) in the factorial experimental program and results in a separate study [24] using the proposed method are shown in Fig. 5. In general, the results obtained with the tested experimental setup are consistent with published data, especially with the data of [27] based on a traditional method in which a constant hydrostatic

pressure of about 3 bar is applied to truncated conical samples until a steady state flow is obtained (approximately 4 weeks). The favourable agreement gives confidence in the validity of the developed method. Permeability coefficients obtained from this study are lower than the results of Ye [28] and Goto *et al.* [7] by one order of magnitude, and higher than the results obtained from beam bending [9] and dynamic pressurization [29] methods although the values from beam bending and dynamic pressurization methods were obtained at earlier curing ages (21 and 14 days, respectively). The differences are attributed to variations in blending of the samples, curing conditions and the fineness of the cement used and especially to differences in the calculation of permeability values between direct and indirect methods. The way to pour and blend cement paste significantly influences the permeability, especially at high w/c ratios in which the cement pastes tend to develop vertical channels [27] if there is no sufficient solution to prevent bleeding. In this study, the bleeding potential was reduced thanks to short height and wide diameter of the mould besides good vibration during casting.

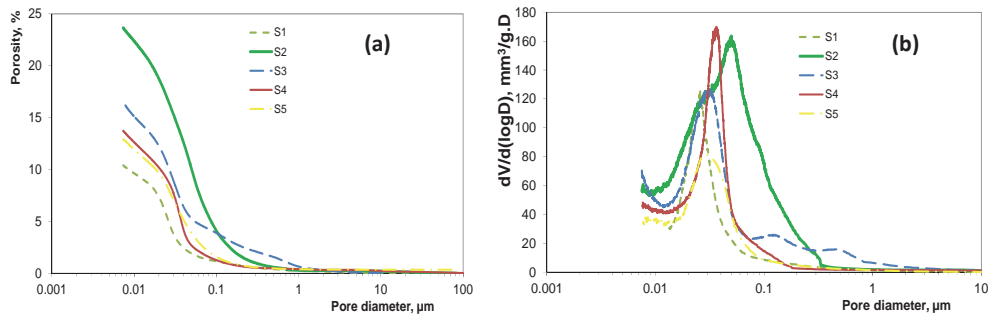

Fig. 4: Porosity versus pore diameter determined by MIP (a) and differential pore size distribution determined by MIP (b)

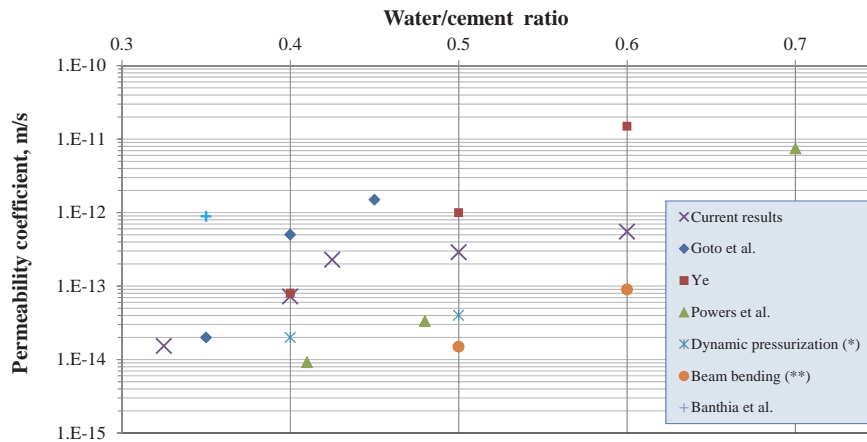

Fig. 5: Permeability of cement pastes at different w/c ratios and comparison of the current test results versus literature data: (*) measured at 21 days of curing, (***) measured at 14 days of curing, for the rest at 28 days of curing

The studied samples were cured in saturated lime water before testing while Ye only cured samples in sealed condition [28]. The degree of hydration of the lime water saturated curing samples is much higher than sealed curing samples; as such, there are more empty pores in the sample under sealed curing conditions [28, 30]. Additionally, the specific surface area ($4350 \text{ cm}^2/\text{g}$) of the Portland cement type I used in this study is higher than the ones used in the studies of Ye and Goto *et al* [7] while lower than the Portland cement type III (ASTM) used in the studies of Vichit-Vadakan *et al.* [9] and Grasley *et al.* [29]. It is believed that the degree of hydration is accelerated if the sample is cured in saturated lime solution and/or when the fineness of the cement is higher. Therefore, the porosity significantly reduces [31] and as a consequence the permeability decreases. The work of Banthia *et al.* [32] also showed a lower permeability of cement type III paste compared to cement type I paste.

The interactions between water and cement matrix could be reduced in this proposed method because the continuous hydration of mature cement paste was limited because of the relatively short measurement time in the proposed method. Furthermore, the measurement was conducted on lime water saturated samples in a closed system which could decrease the dissolution of $\text{Ca}(\text{OH})_2$ and the carbonation of dissolved $\text{Ca}(\text{OH})_2$ – one of the main mechanisms of self-healing property of cement-based materials [33].

3.3. Discussion on the effect of limestone filler and w/p ratio on permeability

In general, the total capillary porosity of cement paste is expected to decrease when its w/p (or w/c) ratio is lower [7, 34-36]. In this study, this trend is confirmed again by increasing 58% and 83% the MIP porosity when w/p ratio increases from 0.325 to 0.425 for sample with and without 20% limestone filler replacement, respectively. The decrease in capillary porosity (which is composed mainly of large and connected pores) leads to a limitation or a decrease of pathways in hardened cement paste resulting in a reduced permeability.

Literature on the effects of limestone filler addition on transport properties of cement-based materials is quite scattered. Most studies [16-18] agree that there is no significant change in transport properties as long as limestone filler replacement is less than 10%. Tsivilis *et al.* [18] measured the gas and water permeability of concretes with different limestone filler replacements (up to 35%). The gas permeability increases with the increase of limestone filler replacement while the water permeability exhibits an opposite behaviour. However, the change in permeability is not that significant (less than 30%) which might not be different enough to overwhelm the error on permeability measurement. The high w/c ratios (0.62 and 0.7) may result in a minor effect on the permeability characteristics as stated by the authors. On the contrary, Matthews [19] found that oxygen permeability decreases with increasing limestone filler replacement (up to 25%). In this case, the w/c ratio is 0.6 which is a bit lower than one of Tsivilis' study. Moir *et al.* [20] also found that the presence of limestone slightly reduces the oxygen permeability concretes made with 5 or 25 % limestone filler replacement. Ramezani-pour *et al.* [16] measured the water penetration depths of concrete mixtures made with 0, 5%, 10%, 15% and 20% limestone filler replacements. The authors found that the minimum water penetration depth is obtained for the mixture with 10% limestone filler replacement. Adding 20% limestone filler replacement results in the worst water permeability regardless curing ages.

Generally, the reduction of transport properties is attributed to the nucleation effect of fine particles of CaCO_3 which refines the pore structure of pastes. The connectivity of the pore structure is reduced. On the other hand, the increase in transport properties normally relies on

the hypothesis that fluid transports faster in the interfacial transition zone between bulk cement paste and limestone particles. Furthermore, water demand (for the same hydration degree) is lower for limestone-cement paste if limestone filler is considered as inert filler. Thus, with the same w/p ratio, more water in limestone-cement paste results in more pores after hydration and setting. In order to know which effects are dominant, knowledge of the quality of limestone filler and cement, which is characterized by particle size distribution, and compositions of both cement and limestone filler is needed. The method to incorporate cement/clinker with limestone (blending or inter-grinding) may affect the properties of limestone-cement-based materials as it might produce somehow different particle size distributions. In this study, limestone filler was added to plain cement by blending. The particle size distribution of the limestone filler was coarser than the one of the cement. For these reasons, it might support the finding that with the same w/c ratio, limestone filler replacement increases the porosity resulted in water permeability increase in this study.

3.4 Correlation between pore structure parameters and water permeability

This section aims at finding how water permeability is correlated to key pore structure parameters as determined by MIP. The main parameter influencing permeability is accessible porosity. However, porosity itself is not well correlated with the water permeability as shown in Fig. 6a. Another factor significantly affecting the water permeability is the pore size distribution which is characterized by several parameters including critical, threshold (the largest pore size at which pore volume is significantly increased) and average pore diameters. Furthermore, water permeability also depends on tortuosity which accounts for the tortuous and reduced transport pathway. However, it is impossible to measure tortuosity directly. The authors of this work tried to relate the water permeability with 2 measurable parameters: accessible porosity and critical pore diameter (from MIP experiments) by modifying the Carman-Kozeny relation [37] as follows:

$$k_w = \zeta d_{cr}^2 \frac{\phi^{2.5}}{(1-\phi)} \quad (2)$$

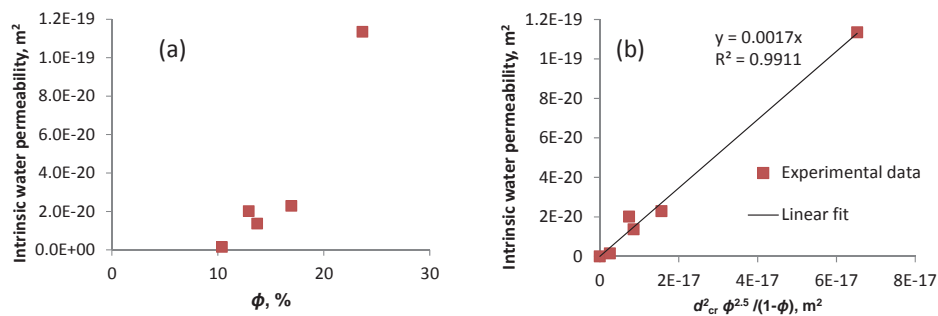

Fig. 6: Correlation of intrinsic water permeability and accessible porosity (a) and $d_{cr}^2 \phi^{2.5} / (1-\phi)$ (b)

By plotting the intrinsic water permeability (converted from hydraulic conductivity) versus $d_{cr}^2 \frac{\phi^{2.5}}{(1-\phi)}$, we found a good correlation with correlation coefficient of 0.99 as shown in Fig.

6. The slope yields value of $\zeta = 0.0017$ [-]. The relationship gives an estimation of permeability if the key parameters (determined by MIP) are known.

4. Conclusions

In this study, the effects of limestone filler replacement and w/p (w/c) ratio on microstructure, and water permeability were investigated. The permeability results obtained from the newly developed method were comparable with results from studies reported in literature even though there were some variations due to differences in sample preparation and cement type. It was observed that both limestone filler and w/p ratio had significant influences on water permeability. Permeability was increased with the increase of w/p ratio and limestone filler replacement. However, there was no interaction effect between w/p ratio and limestone filler replacement in the testing range (w/p = 0.325; 0.375; 0.425 and ls/p = 0; 0.1; 0.2). At a given w/p ratio, adding limestone filler made the capillary pore coarser, especially for high w/p ratio. Nevertheless, if the comparison is based on a given w/c ratio instead of w/p ratio, the limestone filler replacement refined the microstructure resulting in permeability decreases of cement pastes.

The water permeability was highly correlated to key pore structure parameters obtained from MIP experiments: accessible porosity and critical pore diameter. A good correlation between intrinsic water permeability and $d_{cr}^2 \frac{\phi^{2.5}}{(1-\phi)}$ was found. However, more experimental data are needed to validate this relation.

Acknowledgements

The financial support by Belgian Nuclear Research Centre (SCK•CEN) is gratefully acknowledged.

References

- [1] Phung QT, Maes N, Jacques D, Bruneel E, Van Driessche I, Ye G, et al. [Effect of limestone fillers on microstructure and permeability due to carbonation of cement pastes under controlled CO2 pressure conditions. Constr Build Mater. 2015;82\(0\):376-390.](#)
- [2] Phung QT, Maes N, Jacques D, De Schutter G, Ye G. Investigation of the changes in microstructure and transport properties of leached cement pastes accounting for mix composition. *Cement and Concrete Research*. 2015.
- [3] Glasser FP, Marchand J, Samson E. Durability of concrete - Degradation phenomena involving detrimental chemical reactions. *Cement and Concrete Research*. 2008;38(2):226-246.

- [4] [Alarcon-Ruiz L, Brocato M, Dal Pont S, Feraille A. Size Effect in Concrete Intrinsic Permeability Measurements. *Transport Porous Med.* 2010;85\(2\):541-564.](#)
- [5] [Bhargava A, Banthia N. Measurement of concrete permeability under stress. *Exp Techniques.* 2006;30\(5\):28-31.](#)
- [6] [Christensen BJ, Mason TO, Jennings HM. Comparison of measured and calculated permeabilities for hardened cement pastes. *Cement and Concrete Research.* 1996;26\(9\):1325-1334.](#)
- [7] [Goto S, Roy DM. The Effect of W-C Ratio and Curing Temperature on the Permeability of Hardened Cement Paste. *Cement and Concrete Research.* 1981;11\(4\):575-579.](#)
- [8] [Soongswang P, Tia M, Bloomquist D. Factors Affecting the Strength and Permeability of Concrete Made with Porous Limestone. *Aci Mater J.* 1991;88\(4\):400-406.](#)
- [9] [Vichit-Vadakan W, Scherer GW. Measuring permeability of rigid materials by a beam-bending method: III, cement paste. *J Am Ceram Soc.* 2002;85\(6\):1537-1544.](#)
- [10] [Wong HS, Zimmerman RW, Buenfeld NR. Estimating the permeability of cement pastes and mortars using image analysis and effective medium theory. *Cement and Concrete Research.* 2012;42\(2\):476-483.](#)
- [11] [Lafhaj Z, Goueygou M, Djerbi A, Kaczmarek M. Correlation between porosity, permeability and ultrasonic parameters of mortar with variable water/cement ratio and water content. *Cement and Concrete Research.* 2006;36\(4\):625-633.](#)
- [12] [Katz AJ, Thompson AH. Quantitative Prediction of Permeability in Porous Rock. *Phys Rev B.* 1986;34\(11\):8179-8181.](#)
- [13] [Das BB, Kondraivendhan B. Implication of pore size distribution parameters on compressive strength, permeability and hydraulic diffusivity of concrete. *Constr Build Mater.* 2012;28\(1\):382-386.](#)
- [14] [Carman PC. Fluid flow through granular beds. *T I Chem Eng-Lond.* 1937;15:150-166.](#)
- [15] [Kozeny J. Über kapillare Leitung des Wassers im Boden. *Akad Wiss Wien.* 1927;136:271-306.](#)
- [16] [Ramezaniapour AA, Ghiasvand E, Nickseresht I, Mahdikhani M, Moodi F. Influence of various amounts of limestone powder on performance of Portland limestone cement concretes. *Cement Concrete Comp.* 2009;31\(10\):715-720.](#)
- [17] [Tsilivilis S, Chaniotakis E, Batis G, Meletiou C, Kasselouri V, Kakali G, et al. The effect of clinker and limestone quality on the gas permeability, water absorption and pore structure of limestone cement concrete. *Cement Concrete Comp.* 1999;21\(2\):139-146.](#)
- [18] [Tsilivilis S, Tsantilas J, Kakali G, Chaniotakis E, Sakellariou A. The permeability of Portland limestone cement concrete. *Cement and Concrete Research.* 2003;33\(9\):1465-1471.](#)
- [19] [Matthews JD. Performance of Limestone Filler Cement Concrete. In: Dhir R, Jones R, editors. *Euro-Cements: Impact of ENV 197 on Concrete Construction.* London, UK: Taylor & Francis; 1994. p. 113-147.](#)
- [20] [Moir GK, Kelham S. Developments in the Manufacture and Use of Portland Limestone Cement. *ACI Special Publication.* 1999;172:797-820.](#)
- [21] [Dhir RK, Limbachiya MC, McCarthy MJ, Chaipanich A. Evaluation of Portland limestone cements for use in concrete construction. *Mater Struct.* 2007;40\(5\):459-473.](#)
- [22] [Courard L, Michel F. Limestone fillers cement based composites: Effects of blast furnace slags on fresh and hardened properties. *Constr Build Mater.* 2014;51\(0\):439-445.](#)
- [23] [Phung QT. Effects of Carbonation and Calcium Leaching on Microstructure and Transport Properties of Cement Pastes \[PhD thesis\]. Belgium: Ghent University; 2015.](#)

- [24] [Phung QT, Maes N, De Schutter G, Jacques D, Ye G. Determination of water permeability of cementitious materials using a controlled constant flow method. Constr Build Mater. 2013;47\(0\):1488-1496.](#)
- [25] [Akima H. A New Method of Interpolation and Smooth Curve Fitting Based on Local Procedures. J ACM. 1970;17\(4\):589-602.](#)
- [26] Minitab I. MINITAB release 17: statistical software for windows. Minitab Inc, USA. 2014.
- [27] Powers TC, Copeland LE, Hayes JC, Mann HM. Permeability of Portland Cement Paste. Journal of The American Concrete Institute. 1954;51-14:285-298.
- [28] [Ye G. Experimental Study & Numerical Simulation of the Development of the Microstructure and Permeability of Cementitious Materials \[Ph.D thesis\]. The Netherlands: Technology University of Delft; 2003.](#)
- [29] [Grasley ZC, Scherer GW, Lange DA, Valenza JJ. Dynamic pressurization method for measuring permeability and modulus: II. cementitious materials. Mater Struct. 2007;40\(7\):711-721.](#)
- [30] [Bentz DP. Three-dimensional computer simulation of portland cement hydration and microstructure development. J Am Ceram Soc. 1997;80\(1\):3-21.](#)
- [31] [Xu ZG, Tang MS, Beaudoin JJ. Relationships between Composition, Structure and Mechanical-Properties of Very Low Porosity Cementitious Systems. Cement and Concrete Research. 1993;23\(1\):187-195.](#)
- [32] [Banthia N, Mindess S. Water Permeability of Cement Paste. Cement and Concrete Research. 1989;19\(5\):727-736.](#)
- [33] [Hearn N, Morley CT. Self-sealing property of concrete - Experimental evidence. Mater Struct. 1997;30\(201\):404-411.](#)
- [34] [Eldieb AS, Hooton RD. Evaluation of the Katz-Thompson Model for Estimating the Water Permeability of Cement-Based Materials from Mercury Intrusion Porosimetry Data. Cement and Concrete Research. 1994;24\(3\):443-455.](#)
- [35] [Cui L, Cahyadi JH. Permeability and pore structure of OPC paste. Cement and Concrete Research. 2001;31\(2\):277-282.](#)
- [36] [Boel V, Audenaert K, De Schutter G, Heirman G, Vandewalle L, Desmet B, et al. Transport properties of self compacting concrete with limestone filler or fly ash. Mater Struct. 2007;40\(5\):507-516.](#)
- [37] [Pop I, Ingham DB. Transport Phenomena in Porous Media II: Elsevier Science; 2002.](#)

